



corian.

SOLID SURFACES

Corian® loves ... bathrooms





With Corian® you can create a calming bathroom space with timeless elegance, or an escape haven with a contemporary feel...

Front cover: Design by Minosa™
This page: Glacier White vanity top



Scoop® vanity by Minosa™ in Venaro White

Corian® loves ...

inspiration	2
sensuality	4
to be breathtaking	6
luxury	8
to be refreshing	10
vanities	11
uniqueness	12
colour	14
Corian® care	16
Corian® renew and repair	16
committment to the environment	17
Compare Corian®	17

Corian® loves ... inspiration

Designed for modern living, Corian® gives your home the attention it deserves. It provides the freedom to create inspired interior designs. It's simply an ideal material for bringing your ideas to life in a way that's all your own.

Corian® is a solid surface material made only by DuPont from a special formulation of natural minerals and pure acrylic. And it combines the strengths of other materials to deliver a surface with unsurpassed practical advantages. Corian® can be heat formed like glass, has the feel of silk, the hygienic properties of stainless steel, a high quality appearance like natural stone, renewable features similar to timber, plus no unsightly joins to catch dirt!

There are lots of materials, but only one Corian®. There are lots of homes, but only one is yours. And that should be the best reason of all to welcome Corian® into your home.



Corian® is a
renewable and
repairable material
– meaning scratches
and chips are never
permanent!





Bath surrounds - Glacia White

Corian® loves ... sensuality

Corian® has a smooth touch and feel that is warmer than other materials. Create a bathroom space that will be sensual and relaxing. Create curves and wrap your bathroom in Corian® to create the ambiance you desire.



Folio washbasin by Boffi, Glacier White

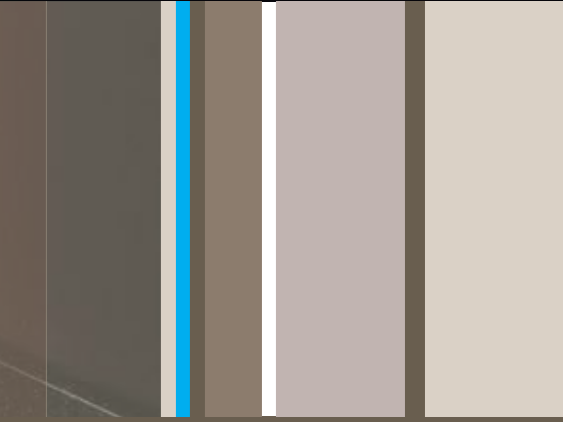

Corian® is warm and inviting to invigorate your senses...

Corian® loves ...
to be breathtaking

Corian® can be turned into personal expression. Let your mind be the limit to endless design possibilities. Create a sculptural elegance that suits your taste and lifestyle. Dream the impossible and make it a reality with Corian®.



The Puddle® by Minosa™. Venaro White



Perceptions The Home Builder. Vanity top - Rice Paper



Corian® loves ... luxury

Stretch your imagination. Create a bathroom space that challenges your perceptions and inspires your senses. Original bathroom pieces fashioned from Corian® highlight a persistent commitment to leading product design. These bathroom luxuries accentuate the strengths of Corian® – long-life renewability, non-porosity, cleanability and warm feel.



The Puddle® by Minosa™. Venaro White

Like lying in a stream with water running around and over you, the Le Cob Bath by Omvivo is the ultimate relaxation vessel.



The Onda Washplane® by Omvivo in Glacier White



Le Cob Bath by Omvivo in Glacier White

The unique Onda Washplane® with its delicate undulating Corian® curves.



Corian® loves ... to be refreshing

Refresh your shower space with Corian®. In the shower, Corian® has a one-wall, continuous look that is sleek and contemporary. Warm to the touch and seamless to the eye, Corian® lets you surround yourself in style and enjoy a new cleansing experience. And only Corian® lets you soak up all the benefits of a luxurious surface without the maintenance. With no failing grout and hard to clean crevices, no other bathroom surface is easier to clean than Corian®.



*Designed & Fabricated by Muzarra
Glacier White 'Pod' Shower Walls, Ceiling and Floors
©2007 Simon Devitt Photographer*

Bath surround in Tranquil



Corian® loves ... vanities



The Pool is a wide brimmed vanity bowl made with Corian® and is a unique alternative to a standard Corian® vanity.



Create a warm and inviting vanity that is smooth to touch. With a Corian® vanity top, no open joints means that it will create a bathroom that is aesthetically and functionally pleasing.

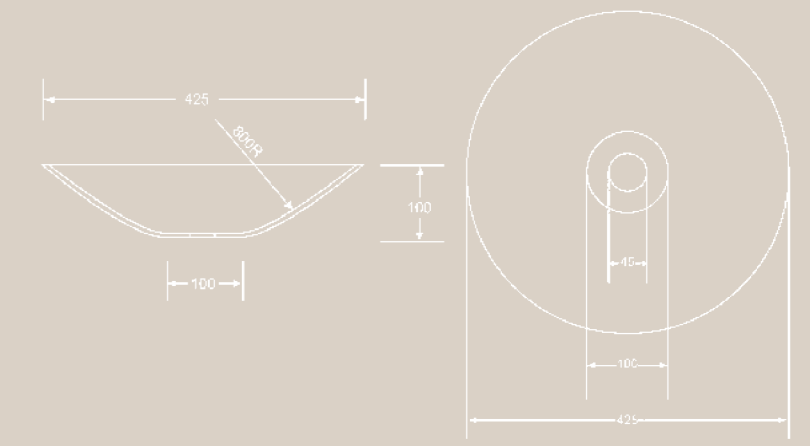



Corian® loves ... uniqueness

With a style and fluidity that offers the chance to 'create'. Corian® has become the material of choice to make a design statement in the home.

Simple shapes, lovingly created and beautifully crafted. Corian® design partners can provide bathroom pieces that blend art and architecture.



Double Pond design by Omvivo



Corian® loves ... colour

The colours you choose speak volumes about your imagination, your character and your spirit. As tools for self-expression, Corian® offers the largest palette of colours in its class. The Colours of Corian® are organised into sub-palettes, complementing the range of materials used in today's homes.

Selecting the Ideal Colour of Corian®

To ensure you gain the greatest satisfaction from owning and living with Corian®, please consider the following information when selecting your colour: When choosing your colour of Corian®, keep in mind that like most materials, dark, heavily pigmented colours are more sensitive and require more care and attention to maintain their look.

Dark colours of Corian® tend to show every day wear and tear, including light scratching, more readily in high use horizontal areas (eg. kitchen benchtops). These colours are marked with an asterisk (*). To ensure we meet your expectations, customers should be aware of the extra care needed. Scratching is not considered a product defect and hence not covered by the 10-year warranty.

Essentials Collection

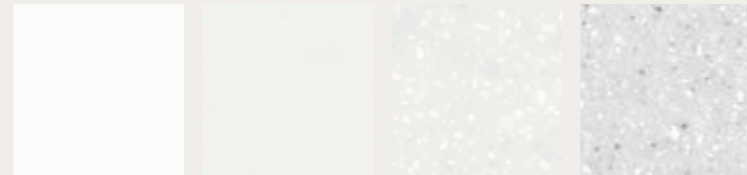

Glacier White[†] 6°, 12, 19mm
Salt[^] NEW 12mm
Antarctica[^] 12mm
Everest[^] 12mm

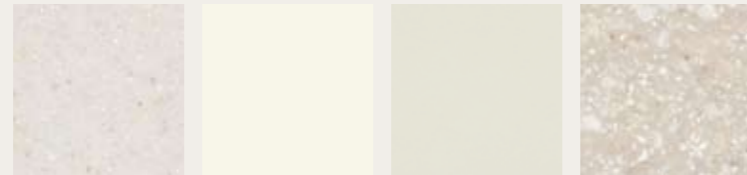

Linen[^] 12mm
Cameo White[†] 6, 12, 19mm
Bisque[†] 12mm
Savannah[^] 12mm



Aurora[^] 6, 12mm
Fossil[^] 12mm
Oyster[^] 12mm
Silver Birch[^] 12mm
Gravel[^] 12mm

Concrete Collection



White Jasmine[^] 12mm
Rice Paper[^] 12mm
Whisper[^] 12mm
Canvas[^] 12mm



Concrete[^] 12mm
Serene Sage[^] 12mm
Dove[^] 12mm

Organics Collection



Cirrus White[^] NEW 12mm



Rain Cloud[^] 12mm
Clam Shell[^] 12mm



Tumbleweed[^] 12mm
Burled Beach[^] 12mm



Sonora[^] 12mm
Sage Brush^{^^} NEW 12mm



Lava Rock^{^^} 12mm
Earth^{^^} 12mm

Other Colours of Corian®

Extra Lights



Venaro White[†] 12mm
Whitecap[^] 12mm



Vanilla[†] 12mm
Festival[^] 12mm
Bone[†] 12mm

Illumination

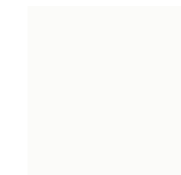

Glacier Ice[‡] # 6, 12mm

Yellow Greens



Tarragon[^] 12mm

Greys



Pearl Grey[†] 12mm
Platinum[^] 12mm

[°] Glacier White available in a 6mm thick, 760mm or 930mm wide sheet. [^] Particulate colour - represents a pattern or spec in the colour. [†] Plain colour - represents a plain, flat colour with no pattern. ~ Venaro White has pronounced veining on one side and subtle veining on the other side. # Glacier Ice is a translucent nature and therefore cannot be clearly represented in this brochure. Please request a sample. Printed representations of colour may vary from actual samples, for particulate colours we highly recommend that you view a large sample before making your final colour choice.

Beiges

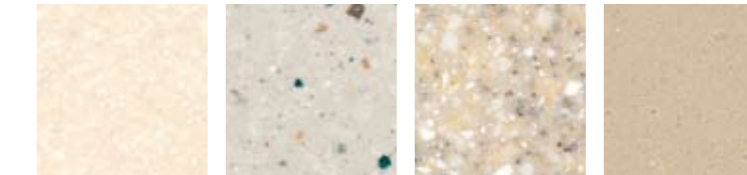

Abalone[^] 12mm
Tumbled Glass[^] 12mm
Sahara[^] 12mm
Raffia[^] 12mm



Winter Wheat[^] 12mm
Beige Fieldstone[^] 12mm
Delta Sand[^] 12mm
Mojave[^] 12mm

Naturals



Pepper Ivory[^] 12mm
Sandstone[^] 12mm
Fawn[^] 12mm
Suede[^] 12mm



Matterhorn[^] 12mm
Silt[^] 12mm
Canyon[^] 12mm
Shale^{^^} 12mm

Extra Darks

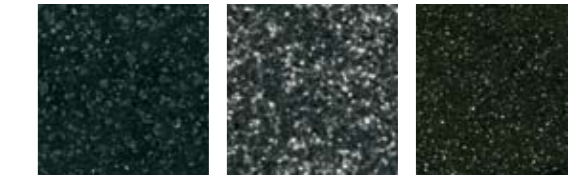

Night Sky^{^^} 12mm
Midnight^{^^} 12mm
Black Quartz^{^^} 12mm

With Corian® you also have the choice of three finishes – matt, satin (standard) and gloss. To achieve a finish that is easy to maintain, a matt or satin finish is recommended.

Your long term satisfaction with Corian® is important to us. Please consult your Corian® specialist or the Corian® Customer Service Centre on 1800 267 426 when choosing your Corian® colour and finish.

To request your free Corian® sample please call 1800 267 426 or visit www.corian.com.au

Corian® Sheet Sizes.
Each colour lists the sheet thickness availability. Sheet sizes are as follows:
Full sheet: 3660 x 760 x 12mm • 2490 x 760 x 6mm
Half sheet: 1828 x 760 x 12mm

Corian® care

Easy living. Depend on Corian® to make your life easier. By nature, Corian® is easy to clean, easy to care for and easy to live with. Corian® is unlike any other material and there is a unique way to look after it. So let go of any assumptions you might have about caring for Corian®!

Corian® care options. Corian® is a trouble-free surface that enjoys amazing practicality. Because Corian® is non-porous liquids can't be absorbed. That means total hygiene and a stainfree surface. Spills disappear effortlessly with a damp cloth or sponge and a simple wipe. Even stubborn stains like red wine, curry paste, beetroot, food acids and oils are no match for Corian®. A firm wipe with a damp sponge and a mild abrasive cleanser will ensure your Corian® surface sparkles.



Corian® prevention tips. Remember, prevention is better than cure. By following the prevention tips outlined in our Corian® Care & Prevention brochure, your surface will continue to perform and to look good for many years to come. Corian® is not a cutting surface. Be sure to use a separate cutting board to avoid deep scratches and the blunting of your knives.

Corian® renew & repair

Corian® was created for life. So even after years of constant use and unexpected mishaps along the way, you can take comfort in knowing that practically anything can be renewed or repaired – a feature unique to Corian®. For more information contact the Corian® Customer Service Centre on 1800 267 426.



Corian® loves ... commitment to the environment

The true colours of Corian® come through in a number of ways that contributes to environmentally sustainable building design. Corian® is repairable, renewable and lasts a long time, which minimises the need to replace or dispose of it. Corian® can be reworked to create new designs and products, generating up to one-third less waste than stone in the fabrication process. Corian® is chemically inert and non-toxic, meeting the most restrictive "food zone" standards. DuPont carefully manages the impact that Corian® has on the environment through responsible choices in raw materials, manufacturing processes and packaging.

Compare Corian®

Corian® combines the strengths of other materials to deliver a surface with unsurpassed practical advantages. It will challenge your perceptions of how a material should look, feel and perform. Corian® can be heat formed like glass, has the feel of silk, the hygienic properties of stainless steel, a high quality appearance like natural stone, renewable features similar to timber, plus joins that basically disappear! With Corian® you can also take comfort in knowing that all but the most severe damage is repairable on site.

Feature	Corian®	Stone	Laminate
No Open Joins	✓	✗	✗
Non-porous	✓	✗	✓
Renewable	✓	✗	✗
Repairable*	✓	✗	✗

* Without having to remove entire benchtop.
For more detailed information on how Corian® compares to other surface materials, please contact the Corian® Customer Service Centre.

Your Corian® quality guarantee

10-year peace of mind. Year after year, with proper care, Corian® will remain as beautiful and elegant as the day it was installed. And DuPont stands by its products with a 10-year warranty on product and installation. Please note, warranty is not available for outdoor applications.

Warranty service centre. DuPont, the creator of Corian® - the original solid surface material - continues to lead the industry with its strong warranty program and comprehensive Warranty Service Centre dedicated to outstanding after-sales customer service.

Register your warranty certificate. In order for us to fulfill our promise to you of years of worry free use with Corian®, please ensure you fill in your DuPont Corian® Warranty Certificate and return it to us. We'll then register your new Corian® surface in our national warranty database.

Quality network. Our team of DuPont Certified Fabricators and Installers are trained in the latest DuPont techniques for working with Corian® solid surfaces. And they're committed to delivering the highest levels of quality and customer service.



At your service

Your Corian® experience. Continued satisfaction makes Corian® a global leader in solid surfaces. Our future depends on meeting your needs and ensuring your experience with Corian® is enjoyable and memorable. CASF Australia, the suppliers of Corian® products, are at your service. Please do not hesitate to contact our Customer Service Centre or Warranty Service Centre on 1800 267 426 or visit our website www.corian.com.au.

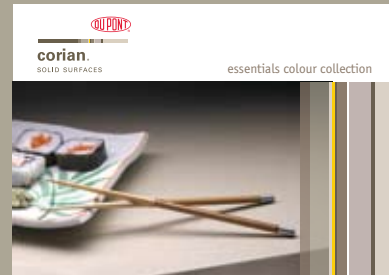
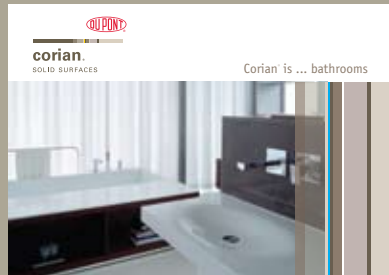

For more information

1800 267 426

www.corian.com.au

© 2008 DuPont. All rights reserved. The DuPont Oval Logo, DuPont™, Corian® solid surfaces are registered trademarks or trademarks of E.I. du Pont de Nemours and Company or its affiliates. Only DuPont makes Corian®.



corian.

SOLID SURFACES